

CRSP Series Non-lighted Single-pole Rocker Switches

Approvals

UL recognized, CSA certified. Load rating: 20A 125/250 VAC. 1 HP, 125/250 VAC. 14A 14VDC, VDE approval 15A. Dielectric strength: 1250 volts (live parts to ground). Life: 35,000 operations at maximum rating. Insulation resistance: 5 megohms.

Low Level Control

For low level/dry circuit applications (<100 ma) contact factory for part number (Gold plated contacts).

High Inrush

125 Amp inrush capability (AgNi contacts).

Terminals

Style A - 1/4-inch quick-connect with fine silver contacts (gold plating available).

Mechanical Features





100,000 mechanical operations

Markings

Letters, numbers and symbols can be applied to rocker actuator or to integral nylon bezel; see inside back cover for details.

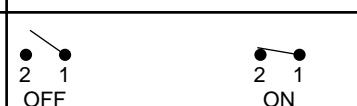
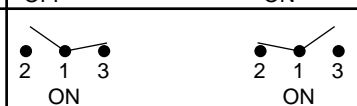
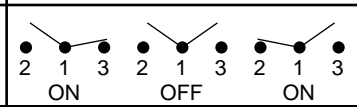
Mounting

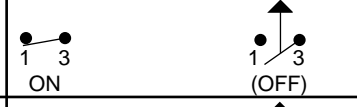
Snap-in type panel mounting for ease of installation without additional mounting hardware.

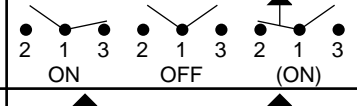
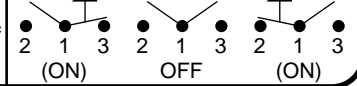
Circuit	Switching	
1	SPST Maintained	
2	SPDT Maintained	
3	SPDT Maintained Center Off	
4	SPST (Momentary) Normally Open	
5	SPDT (Momentary) Normally Closed	
6	SPDT (Momentary) Transfer	
7	SPDT Maintained Center Off (Momentary)	
8	SPDT (Momentary) Center Off (Momentary)	

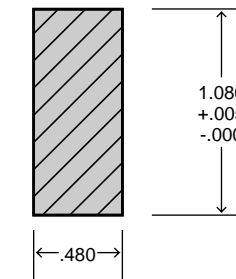
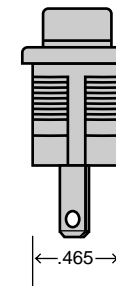
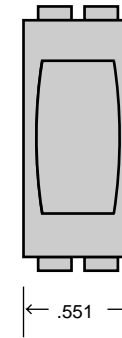
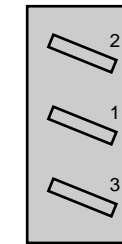
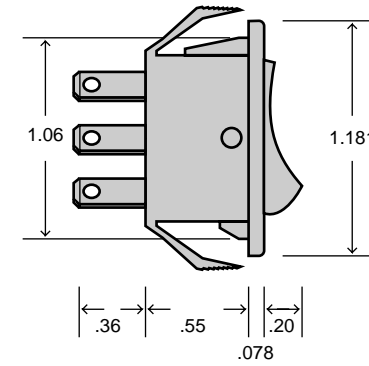

Panel Cut Out
Panel Thickness 1/32" - 3/16"



Ordering Information:

CRSP



Circuit

- 1=SPST Maintained
- 2=SPDT Maintained
- 3=SPDT Maintained Center Off
- 4=SPST (Momentary) Normally Open
- 5=SPST (Momentary) Normally Closed
- 6=SPDT (Momentary) Transfer
- 7=SPDT Maintained Center Off (Momentary)
- 8=SPDT (Momentary) Center Off (Momentary)

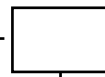

Terminal Option

- A=Fine Silver (Normal Duty)
- G=Gold Plated Contacts
- H=High Inrush Contacts

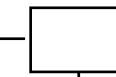

Actuator Color

- 7=White
- 9=Black
- 12=Red

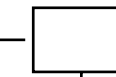

Housing Color

- M9=Matte Black
- (For other colors contact factory)



Accessories (Optional)

- T=Boot