

# CRSP Series Non-lighted Single-pole Rocker Switches

## Approvals

UL recognized, CSA certified. Load rating: 20A 125/250 VAC. 1 HP, 125/250 VAC. 14A 14VDC, VDE approval 15A. Dielectric strength: 1250 volts (live parts to ground). Life: 35,000 operations at maximum rating. Insulation resistance: 5 megohms.

## Low Level Control

For low level/dry circuit applications (<100 ma) contact factory for part number (Gold plated contacts).

## High Inrush

125 Amp inrush capability (AgNi contacts).

## Terminals

Style A - 1/4-inch quick-connect with fine silver contacts (gold plating available).

## Mechanical Features





100,000 mechanical operations

## Markings

Letters, numbers and symbols can be applied to rocker actuator or to integral nylon bezel; see inside back cover for details.

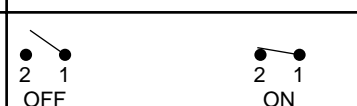
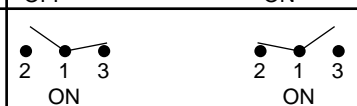
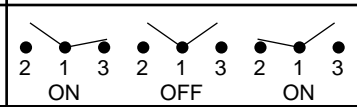
## Mounting

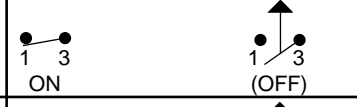
Snap-in type panel mounting for ease of installation without additional mounting hardware.

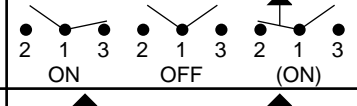
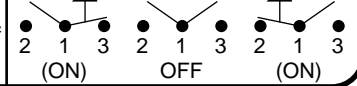
| Circuit | Switching                               |    |
|---------|---|---|
| 1       | SPST Maintained                         |    |
| 2       | SPDT Maintained                         |    |
| 3       | SPDT Maintained Center Off              |    |
| 4       | SPST (Momentary) Normally Open          |    |
| 5       | SPDT (Momentary) Normally Closed        |    |
| 6       | SPDT (Momentary) Transfer               |   |
| 7       | SPDT Maintained Center Off (Momentary)  |  |
| 8       | SPDT (Momentary) Center Off (Momentary) |  |

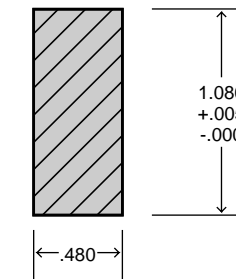
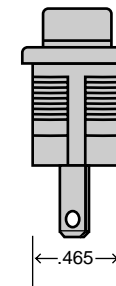
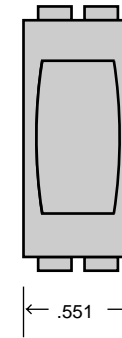
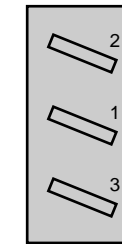
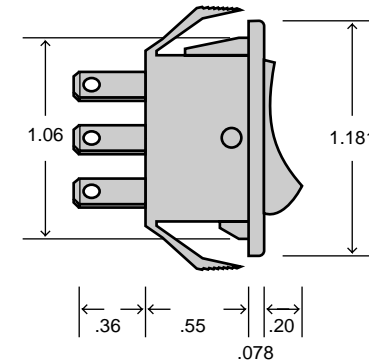

Panel Cut Out  
Panel Thickness 1/32" - 3/16"



## Ordering Information:

**CRSP**



### Circuit

- 1=SPST Maintained
- 2=SPDT Maintained
- 3=SPDT Maintained Center Off
- 4=SPST (Momentary) Normally Open
- 5=SPST (Momentary) Normally Closed
- 6=SPDT (Momentary) Transfer
- 7=SPDT Maintained Center Off (Momentary)
- 8=SPDT (Momentary) Center Off (Momentary)

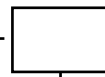

### Terminal Option

- A=Fine Silver (Normal Duty)
- G=Gold Plated Contacts
- H=High Inrush Contacts

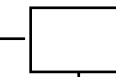

### Actuator Color

- 7=White
- 9=Black
- 12=Red

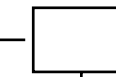

### Housing Color

- M9=Matte Black
- (For other colors contact factory)



### Accessories (Optional)

- T=Boot